

# PD004065EF / PD004065EF\_G

## 650V Silicon Carbide Diode

### Features

- 650-Volt Schottky Rectifier
- Shorter recovery time
- High-speed switching possible
- High-Frequency Operation
- Temperature-Independent Switching Behavior
- Extremely Fast Switching
- Positive Temperature Coefficient on VF
- RoHS Compliant

### Applications

- Switch Mode Power Supplies
- Power Factor Correction
- Motor Drives
- HID Lighting

### Package Outline

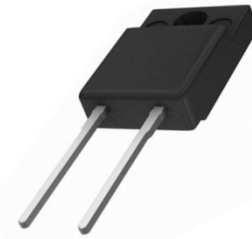

Cathode Anode

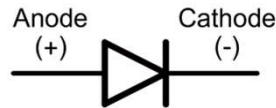

### Absolute Maximum Ratings

Symbol	Parameter	Value	Units
$V_{RRM}$	Repetitive Peak Reverse Voltage	650	V
$V_{RSM}$	Surge Peak Reverse Voltage	650	V
$V_{DC}$	DC Blocking Voltage	650	V
$I_F$	Continuous Forward Current $T_C = 25^\circ\text{C}$ $T_C = 140^\circ\text{C}$	9 4	A
$I_{FRM}$	Repetitive Peak Forward Current $T_C = 110^\circ\text{C}$	21	A
$I_{FSM}$	Non-Repetitive Forward Surge Current (PW=10ms sinusoidal) $T_C = 25^\circ\text{C}$ $T_C = 110^\circ\text{C}$	20 16	A
$P_D$	Power Dissipation $T_C = 25^\circ\text{C}$	30	W
$T_J, T_{stg}$	Operating Junction and Storage Temperature	-55 to +175	$^\circ\text{C}$

**Electrical Characteristics** $T_C = 25^\circ\text{C}$  unless otherwise noted

Symbol	Parameter	Test Conditions	Min	Typ	Max	Units
$V_F$	Forward Voltage	$I_F = 4\text{A}, T_C = 25^\circ\text{C}$ $I_F = 4\text{A}, T_C = 175^\circ\text{C}$	--	1.5 2.0	1.8 2.4	V
$I_R$	Reverse Current	$V_R = 650\text{V}, T_C = 25^\circ\text{C}$ $V_R = 650\text{V}, T_C = 175^\circ\text{C}$	--	14 28	38 380	$\mu\text{A}$
$Q_C$	Total Capacitive Charge	$V_R = 400\text{V}$	--	10	--	nC
C	Total Capacitance	$V_R = 1\text{V}, T_J = 25^\circ\text{C}, f = 1\text{MHz}$ $V_R = 520\text{V}, T_J = 25^\circ\text{C}, f = 1\text{MHz}$	--	180 25	--	pF

**Thermal Characteristics** $T_C = 25^\circ\text{C}$  unless otherwise noted

Symbol	Parameter	Min	Typ	Max	Units
$R_{\theta JC}$	Thermal Resistance, Junction-to-Case	--	5.0	6.0	$^\circ\text{C}/\text{W}$

**Package Marking and Ordering Information**

Device Marking	Device	Package	Reel Size	Tape Width	Quantity
PD004065EF	PD004065EF	TO-220F	-	-	50
PD004065EF_G	PD004065EF_G	TO-220F	-	-	50

\* PD004065EF\_G : RoHS Compliant

### Typical Characteristics

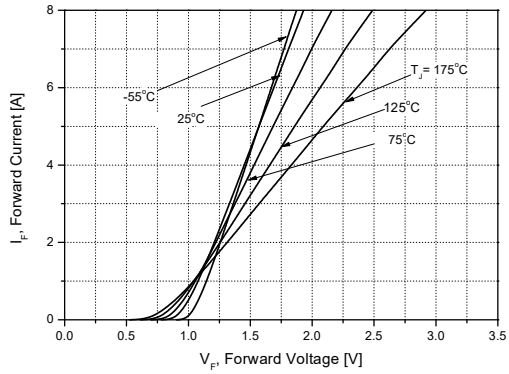

Figure 1. Forward Characteristics

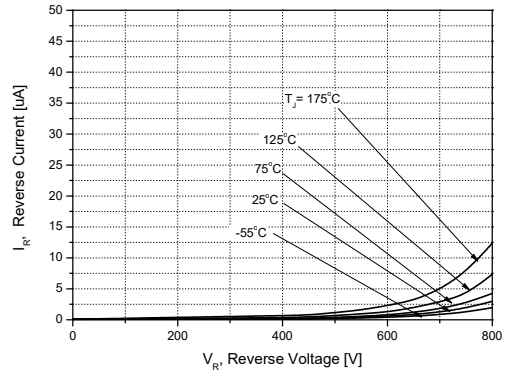

Figure 2. Reverse Characteristics

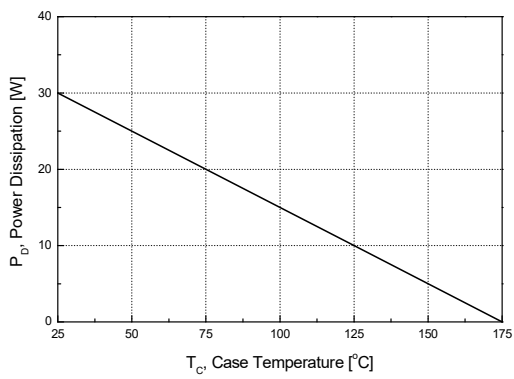

Figure 3. Power Dissipation

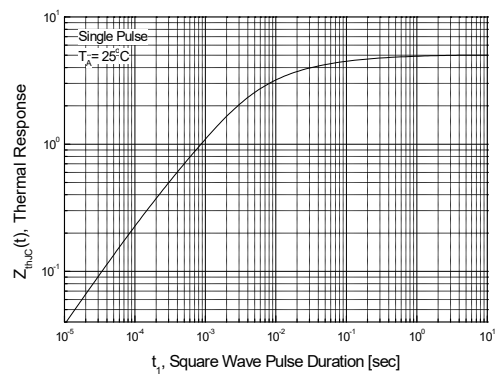

Figure 4. Transient Thermal Resistance

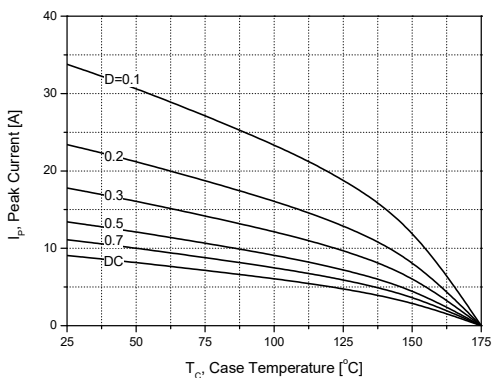

Figure 5. Peak Forward Current Derating

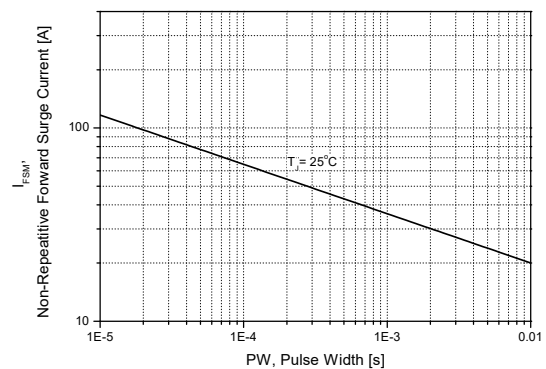
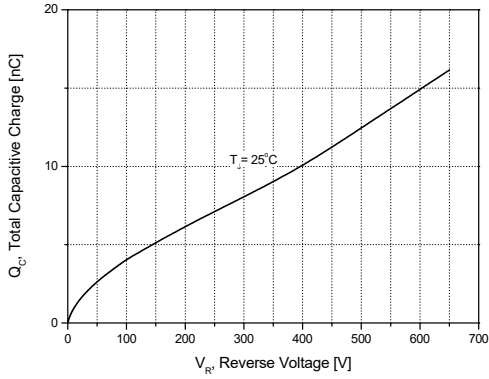
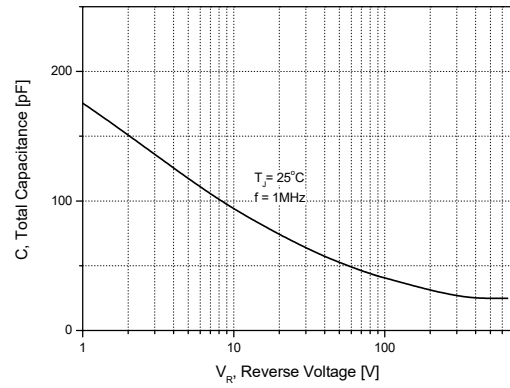

Figure 6. Non-Repetitive Peak Forward Surge Current vs. Pulse Duration

## Typical Characteristics



**Figure 7. Total Capacitive Charge**



**Figure 8. Total Capacitance**

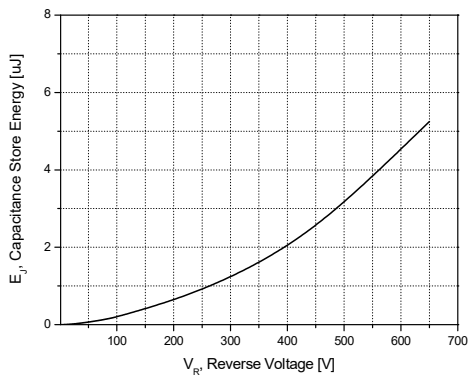

**Figure 9. Capacitance Store Energy**

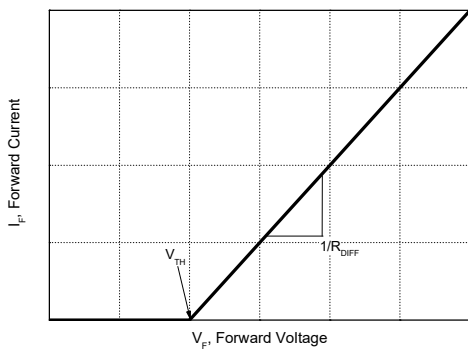

**Figure 10. Equivalent Forward Current Curve**

$$V_F = V_{TH} + R_{DIFF} \times I_F$$

### Threshold Voltage( $V_{TH}$ )

$$V_{TH}(T_j) = -0.001 \times (T_j) + 0.950 \text{ [V]}$$

### Differential Resistance ( $R_{DIFF}$ )

$$R_{DIFF}(T_j) = A \times T_j^2 + B \times T_j + C \text{ [\Omega]}$$

$$A = 2.56 \times 10^{-6}$$

$$B = 4.46 \times 10^{-4}$$

$$C = 10.9 \times 10^{-2}$$

$$[T_j \text{ [}^\circ\text{C]}; -55 \text{ }^\circ\text{C} \leq T_j \leq 175 \text{ }^\circ\text{C}; I_F \leq 4 \text{ A}]$$

Package Information

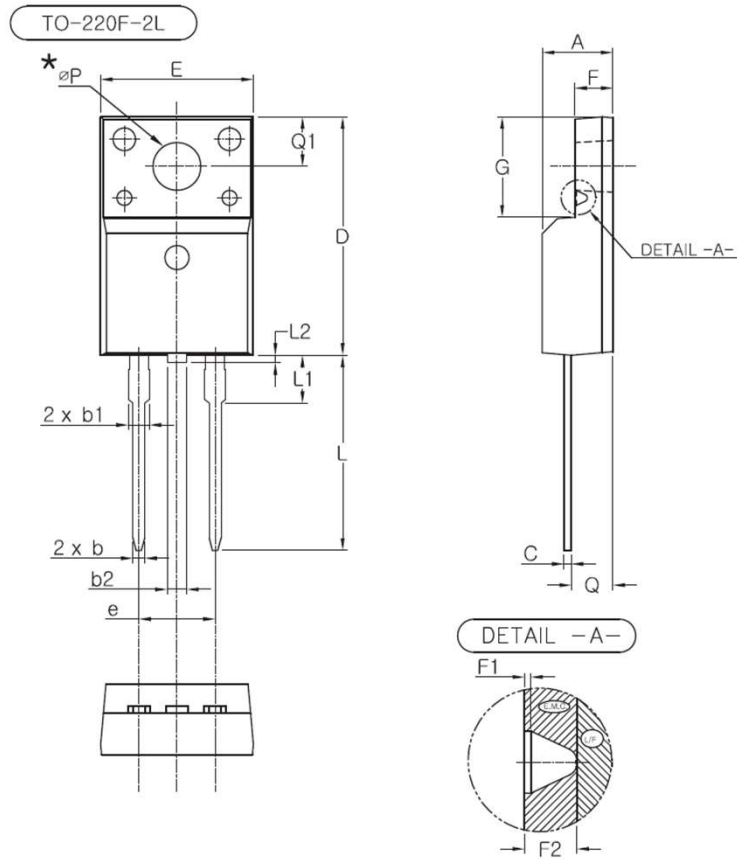

SYMBOL	MIN	NOM	MAX
A	4.50	4.70	4.90
b	0.70	0.80	0.90
b1	1.33	1.40	1.47
b2	0.98	1.28	1.58
C	0.45	0.50	0.60
D	15.67	15.87	16.07
E	9.96	10.16	10.36
e	5.08 BSC		
F	2.34	2.54	2.74
F1	(0.10)		
F2	(0.84)		
G	6.48	6.68	6.88
L	12.78	12.98	13.18
L1	2.98	3.18	3.38
L2	-	-	0.80
Q	2.56	2.76	2.96
Q1	3.10	3.30	3.50
*øP	3.08	3.18	3.28

NOTE

1. THESE DIMENSIONS DO NOT INCLUDE PROTRUSIONS OF THE MOLD.
2. THE '( )' MARK IS THE REFERENCE
3. THE 'L2' SYMBOL IS A PROTRUSION OF THE MOLD.

### Packing Information

#### Inner Box

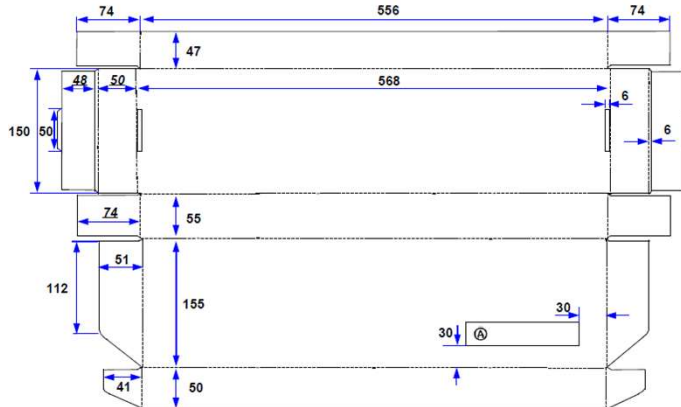

PART ID PDXXXXXXEX_G	PKG Type XX-XXXX-XX
LOT No. XXXXXXXXXXXXXX	QTY X,XXX ea
DATE : XXXX.XX.XX	

#### Outer Box

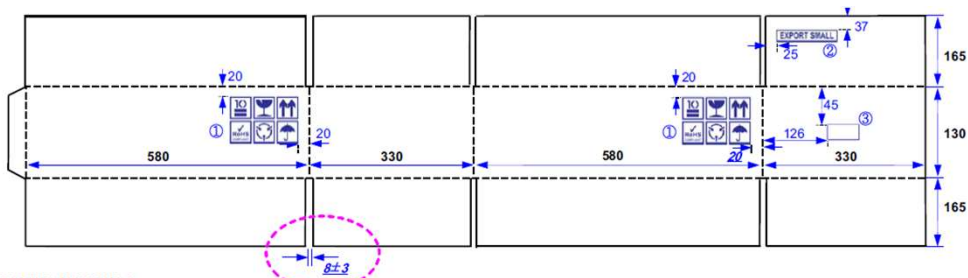

[ BOX PRINTING MARKING ]



MARKING SIZE (Each Symbol 30\*30)  
COLOR (DARK BLUE)

- ② **EXPORT SMALL**  
MARKING SIZE (112\*20)  
COLOR (DARK BLUE)
- ③   
LABEL MARKING SIZE (75\*35)  
COLOR (DARK BLUE)

- [ NOTE ]
- MATERIAL : KLB175\*K180\*KLB175\*K180\*KLB175  
(SUK175\*K200\*K200\*K200\*SUK175)
  - NAIL QTY : 3 PCS
  - PRINTING TOLERANCE : MARKING SIZE(±3)  
MARKING POSITION(±5)

PART ID : PDXXXXXXEX_G	
LOT NO : XXXXXXXXXXXXX	
QTY : XX,XXXX ea	
DATE : XXXX.XX.XX	

## Notes

- A. Specifications mentioned in this publication are subject to change without notice.
- B. Before you use our Products, please contact our sales representative and verify the latest specifications.
- C. In order to prevent personal injury or fire arising from failure, please take safety measures such as complying with the derating characteristics, implementing redundant and fire prevention designs, and utilizing backups and fail-safe procedures.
- D. YES POWERTECHNIX shall have no responsibility for any damages arising out of the use of our products beyond the rating specified by YES POWERTECHNIX.
- E. The technical information specified herein is intended only to show the typical functions of and examples of application circuits for the Products.
- F. YES POWERTECHNIX does not grant you, explicitly or implicitly, any license to use or exercise intellectual property or other rights held by YES POWERTECHNIX or any other parties.
- G. YES POWERTECHNIX shall have no responsibility whatsoever for any dispute arising out of the use of such technical information.
- H. Please use the Products in accordance with any applicable environmental laws and regulations, such as the RoHS Directive.
- I. YES POWERTECHNIX shall have no responsibility for any damages or losses resulting non-compliance with any applicable laws or regulations.
- J. This document, in part or in whole, may not be reprinted or reproduced without prior consent of YES POWERTECHNIX.

