

## General Description

FSMOS<sup>®</sup> MOSFET is based on Oriental Semiconductor's unique device design to achieve low  $R_{DS(ON)}$ , low gate charge, fast switching and excellent avalanche characteristics. The low  $V_{th}$  series is specially designed to use in synchronous rectification power systems with low driving voltage.

## Features

- Low  $R_{DS(ON)}$  & FOM
- Extremely low switching loss
- Excellent reliability and uniformity
- Fast switching and soft recovery



## Applications

- PD charger
- Motor driver
- Switching voltage regulator
- DC-DC convertor
- Switched mode power supply

## Key Performance Parameters

Parameter	Value	Unit
$V_{DS, min} @ T_{j(max)}$	60	V
$I_{D, pulse}$	480	A
$R_{DS(ON) max} @ V_{GS}=10V$	2.5	m $\Omega$
$Q_g$	106	nC

## Marking Information

Product Name	Package	Marking
SFS06R02DF	TO252	SFS06R02D

## Package & Pin information

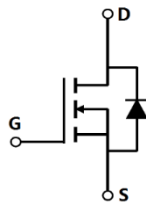

**Absolute Maximum Ratings** at  $T_j=25^{\circ}\text{C}$  unless otherwise noted

Parameter	Symbol	Value	Unit
Drain source voltage	$V_{DS}$	60	V
Gate source voltage	$V_{GS}$	$\pm 20$	V
Continuous drain current <sup>1)</sup> , $T_C=25^{\circ}\text{C}$	$I_D$	160	A
Pulsed drain current <sup>2)</sup> , $T_C=25^{\circ}\text{C}$	$I_{D, pulse}$	480	A
Continuous diode forward current <sup>1)</sup> , $T_C=25^{\circ}\text{C}$	$I_S$	160	A
Diode pulsed current <sup>2)</sup> , $T_C=25^{\circ}\text{C}$	$I_{S, Pulse}$	480	A
Power dissipation <sup>3)</sup> , $T_C=25^{\circ}\text{C}$	$P_D$	132	W
Single pulsed avalanche energy <sup>5)</sup>	$E_{AS}$	240	mJ
Operation and storage temperature	$T_{stg}, T_j$	-55 to 150	$^{\circ}\text{C}$

**Thermal Characteristics**

Parameter	Symbol	Value	Unit
Thermal resistance, junction-case	$R_{\theta JC}$	0.95	$^{\circ}\text{C/W}$
Thermal resistance, junction-ambient <sup>4)</sup>	$R_{\theta JA}$	62	$^{\circ}\text{C/W}$

**Electrical Characteristics** at  $T_j=25^{\circ}\text{C}$  unless otherwise specified

Parameter	Symbol	Min.	Typ.	Max.	Unit	Test condition
Drain-source breakdown voltage	$BV_{DSS}$	60			V	$V_{GS}=0\text{ V}, I_D=250\ \mu\text{A}$
Gate threshold voltage	$V_{GS(th)}$	1.0		2.5	V	$V_{DS}=V_{GS}, I_D=250\ \mu\text{A}$
Drain-source on-state resistance	$R_{DS(ON)}$		2.3	2.5	m $\Omega$	$V_{GS}=10\text{ V}, I_D=20\text{ A}$
Drain-source on-state resistance	$R_{DS(ON)}$		2.9	4.0	m $\Omega$	$V_{GS}=4.5\text{ V}, I_D=10\text{ A}$
Gate-source leakage current	$I_{GSS}$			100	nA	$V_{GS}=20\text{ V}$
				-100		$V_{GS}=-20\text{ V}$
Drain-source leakage current	$I_{DSS}$			1	$\mu\text{A}$	$V_{DS}=60\text{ V}, V_{GS}=0\text{ V}$
Gate resistance	$R_G$		1.8		$\Omega$	$f=1\text{ MHz}, \text{Open drain}$

### Dynamic Characteristics

Parameter	Symbol	Min.	Typ.	Max.	Unit	Test condition
Input capacitance	$C_{iss}$		6498		pF	$V_{GS}=0\text{ V}$ , $V_{DS}=25\text{ V}$ , $f=100\text{ kHz}$
Output capacitance	$C_{oss}$		1260		pF	
Reverse transfer capacitance	$C_{rss}$		52		pF	
Turn-on delay time	$t_{d(on)}$		27.5		ns	$V_{GS}=10\text{ V}$ , $V_{DS}=50\text{ V}$ , $R_G=2\ \Omega$ , $I_D=50\text{ A}$
Rise time	$t_r$		8.1		ns	
Turn-off delay time	$t_{d(off)}$		84.5		ns	
Fall time	$t_f$		18.3		ns	

### Gate Charge Characteristics

Parameter	Symbol	Min.	Typ.	Max.	Unit	Test condition
Total gate charge	$Q_g$		106		nC	$V_{GS}=10\text{ V}$ , $V_{DS}=50\text{ V}$ , $I_D=50\text{ A}$
Gate-source charge	$Q_{gs}$		16.3		nC	
Gate-drain charge	$Q_{gd}$		19		nC	
Gate plateau voltage	$V_{plateau}$		3.3		V	

### Body Diode Characteristics

Parameter	Symbol	Min.	Typ.	Max.	Unit	Test condition
Diode forward voltage	$V_{SD}$			1.3	V	$I_S=20\text{ A}$ , $V_{GS}=0\text{ V}$
Reverse recovery time	$t_{rr}$		86.8		ns	$V_R=50\text{ V}$ , $I_S=50\text{ A}$ , $di/dt=100\text{ A}/\mu\text{s}$
Reverse recovery charge	$Q_{rr}$		130.4		nC	
Peak reverse recovery current	$I_{rrm}$		2.5		A	

### Note

- 1) Calculated continuous current based on maximum allowable junction temperature.
- 2) Repetitive rating; pulse width limited by max. junction temperature.
- 3)  $P_d$  is based on max. junction temperature, using junction-case thermal resistance.
- 4) The value of  $R_{\theta JA}$  is measured with the device mounted on 1 in 2 FR-4 board with 2oz. Copper, in a still air environment with  $T_a=25\text{ }^\circ\text{C}$ .
- 5)  $V_{DD}=30\text{ V}$ ,  $V_{GS}=10\text{ V}$ ,  $L=0.3\text{ mH}$ , starting  $T_j=25\text{ }^\circ\text{C}$ .

**Electrical Characteristics Diagrams**

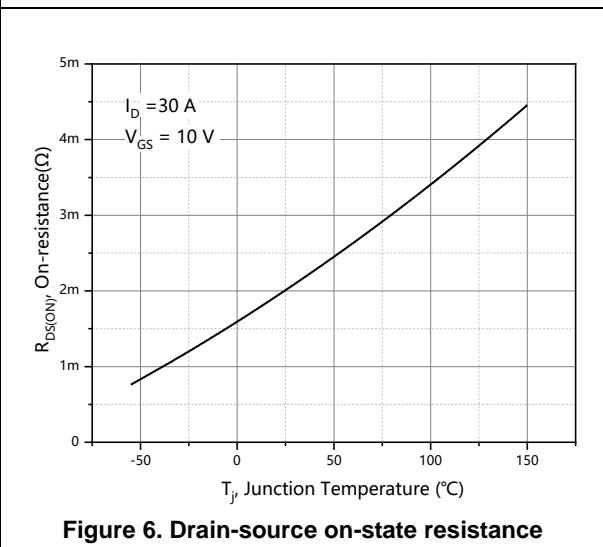
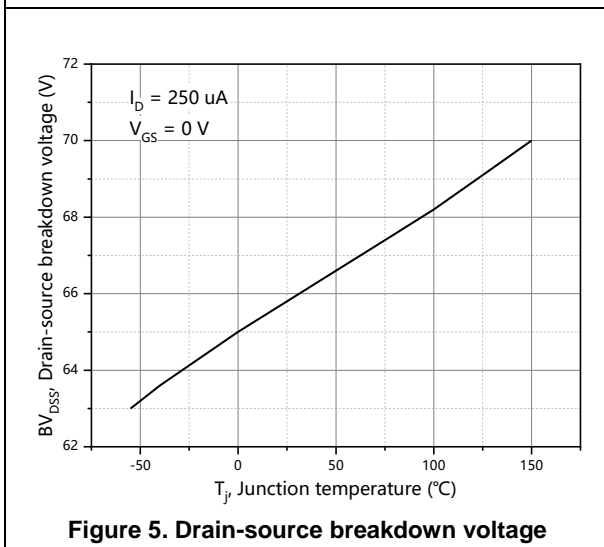
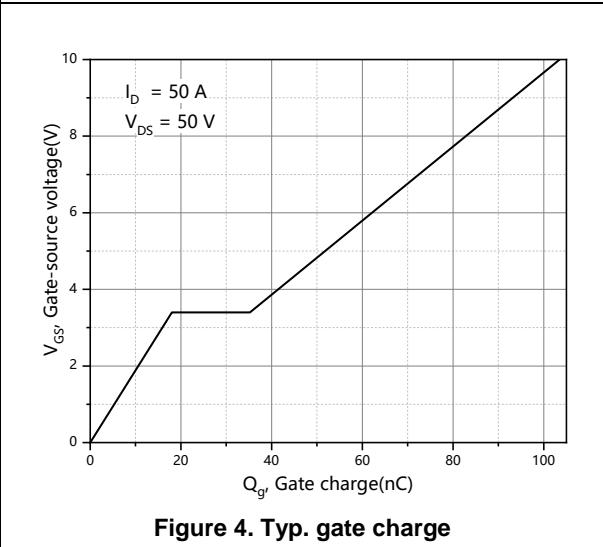
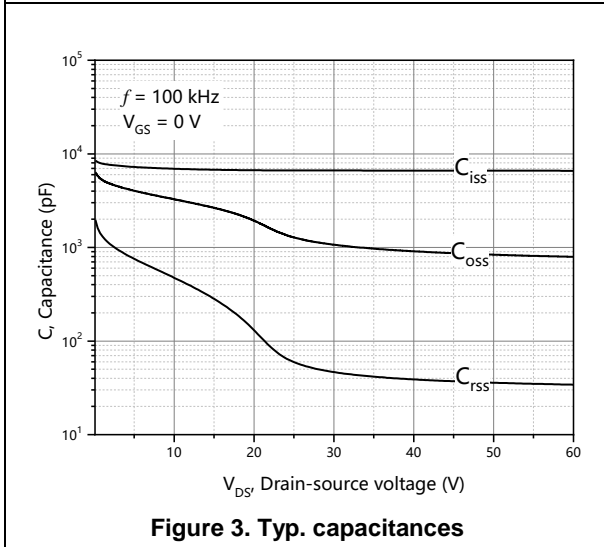
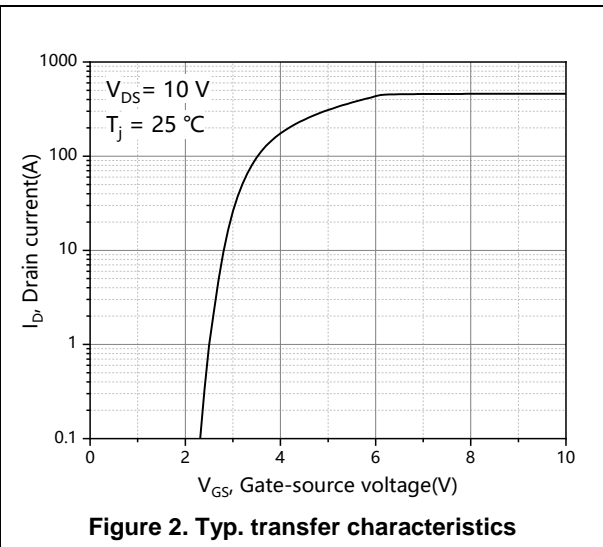
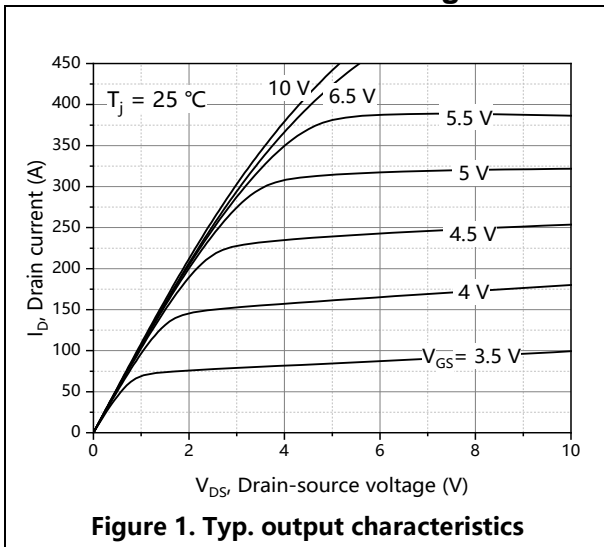

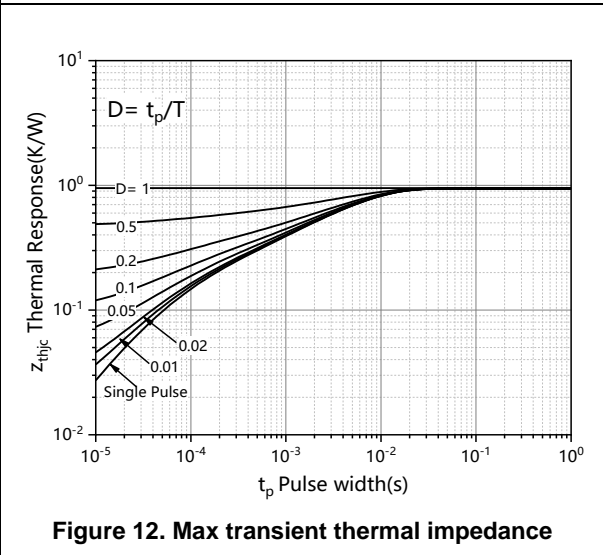
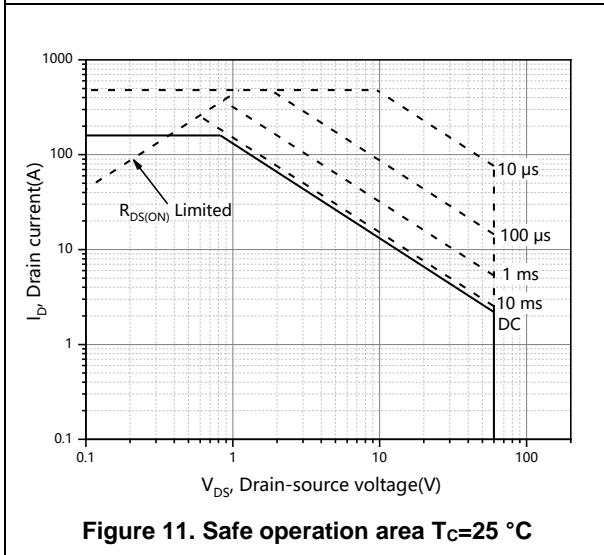
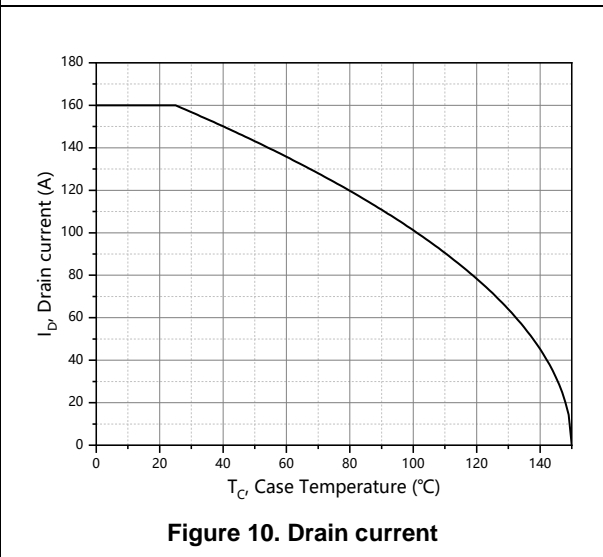
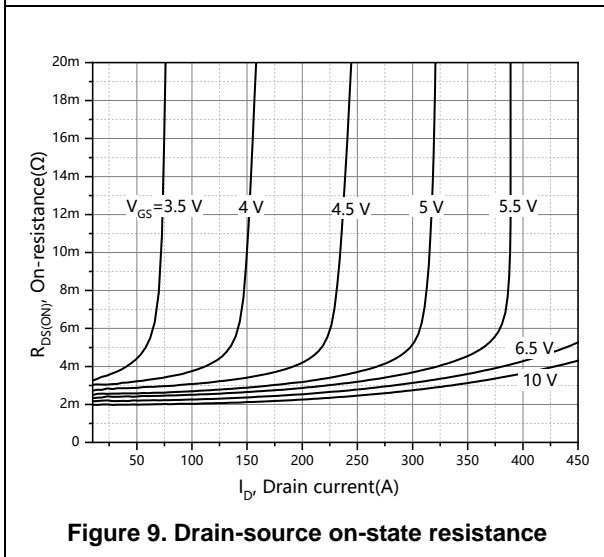
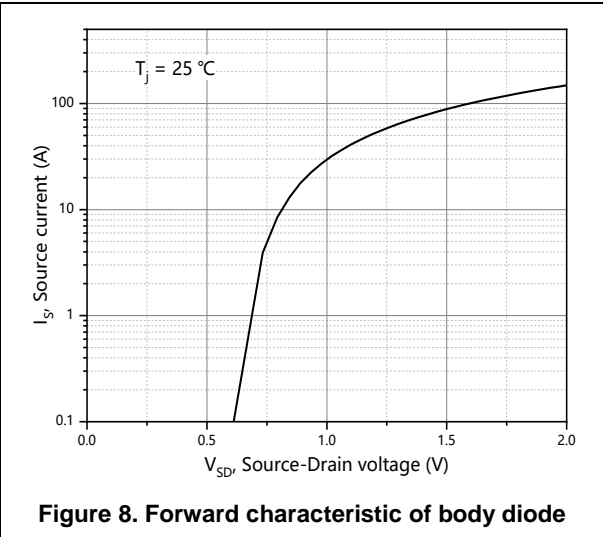
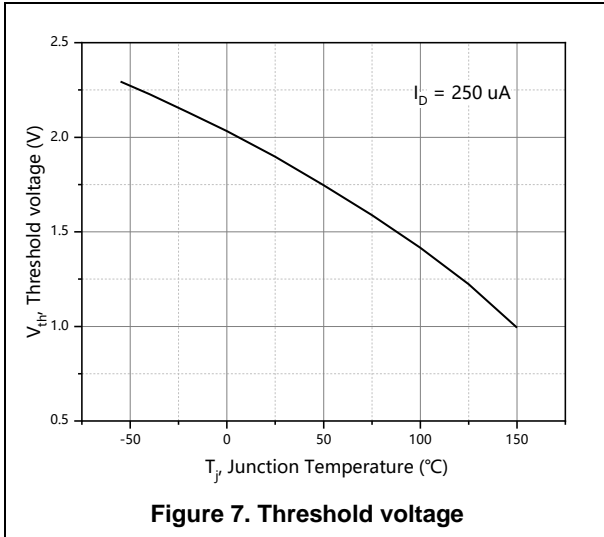

**Test circuits and waveforms**



**Figure 1. Gate charge test circuit & waveform**



**Figure 2. Switching time test circuit & waveforms**

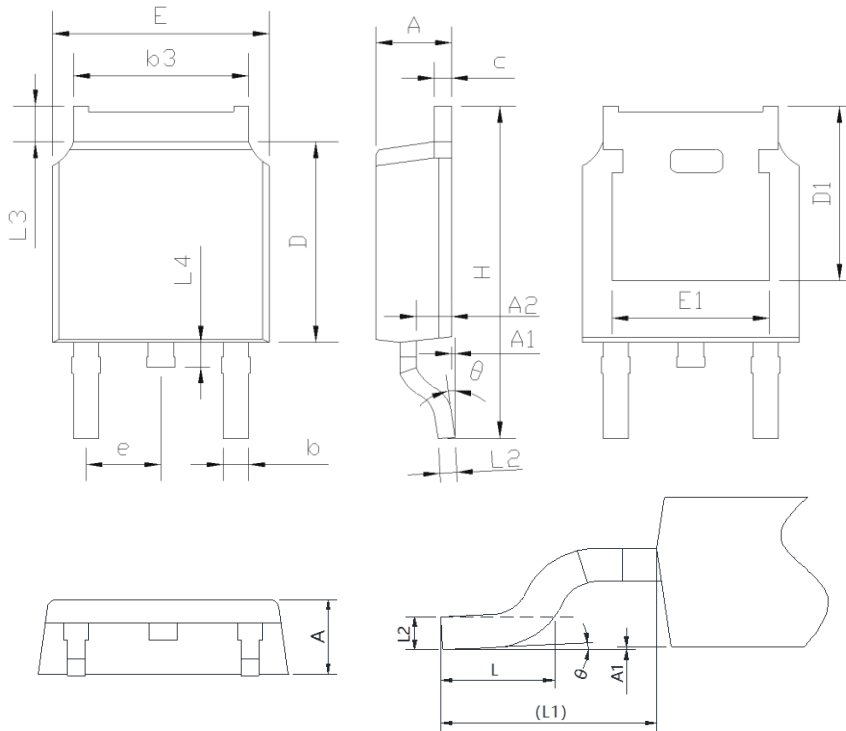

**Figure 3. Unclamped inductive switching (UIS) test circuit & waveforms**



**Figure 4. Diode reverse recovery test circuit & waveforms**

**Package Information**



Symbol	mm		
	Min	Nom	Max
A	2.20	2.30	2.38
A1	0.00	-	0.20
A2	0.97	1.07	1.17
b	0.68	0.78	0.90
b3	5.20	5.33	5.46
c	0.43	0.53	0.61
D	5.98	6.10	6.22
D1	5.30 REF		
E	6.40	6.60	6.73
E1	4.63	-	-
e	2.286 BSC		
H	9.40	10.10	10.50
L	1.38	1.50	1.75
L1	2.90 REF		
L2	0.51 BSC		
L3	0.88	-	1.28
L4	0.50	-	1.00
θ	0°	-	8°

Version 1: TO252-P package outline dimension

## Ordering Information

Package Type	Units/ Reel	Reels / Inner Box	Units/ Inner Box	Inner Boxes/ Carton Box	Units/ Carton Box
TO252-P	2500	2	5000	5	25000

## Product Information

Product	Package	Pb Free	RoHS	Halogen Free
SFS06R02DF	TO252	yes	yes	yes

## Legal Disclaimer

The information given in this document shall in no event be regarded as a guarantee of conditions or characteristics. With respect to any examples or hints given herein, any typical values stated herein and/or any information regarding the application of the device, Oriental Semiconductor hereby disclaims any and all warranties and liabilities of any kind, including without limitation, warranties of non-infringement of intellectual property rights of any third party.

For further information on technology, delivery terms and conditions and prices, please contact the Oriental Semiconductor sales representatives ([www.orientalsemi.com](http://www.orientalsemi.com)).

© Oriental Semiconductor Co.,Ltd. All Rights Reserved 